

# Kiosk, Vending and Ticketing Components





# Table of Contents

About SUZOHAPP.....	4	<b>CLOSED LOOP CASHLESS SYSTEMS</b>	
Manufacturing Capabilities .....	6	WorldKey Systems.....	28
R&D Capabilities .....	8		
		<b>DISPLAYS</b>	
<b>BILL VALIDATORS &amp; RECYCLERS</b>		VisionPro™ LCDs .....	29
Bill-to-Bill™ Range .....	13	Elo Open-Frame Touch Monitors .....	30
Bill-to-Bill™ 300 .....	13		
Bill-to-Bill XE™ .....	14	<b>PRINTERS</b>	
Bill-to-Bill TD™ Top Dispenser .....	15	Nanoptix®.....	32
Bill-to-Bill ST™ Stackerless .....	15	Custom® .....	34
MFL .....	16		
Vantage.....	17		
		<b>PUSHBUTTONS</b>	
<b>COIN VALIDATORS &amp; RECYCLERS</b>		Dynamic Panel Systems.....	35
Currenza C² .....	18	Chrome-Luminescent Pushbuttons .....	36
RM5 HD .....	19	STC Pushbuttons.....	36
RM5 Evolution .....	19	LCD Pushbuttons.....	36
Coin Sorters.....	20		
		<b>LOCKS</b>	
<b>HOPPERS</b>		Xlocks & STC .....	37
ICS.....	21	E-PRL™ .....	38
Cube Hopper .....	22		
Flow Hopper .....	22	<b>ACCESSORIES</b>	
Evolution Hopper .....	23	Speakers and Amplifiers .....	40
Excel Hopper .....	23	Power Supplies and Line Filters .....	40
WGR.....	24	LED Light Strips.....	41
		Lamps .....	41
<b>CASHLESS</b>		Proximity Sensor.....	41
UPT Card Readers.....	25	Door Switches .....	42
		Cooling Fans.....	42
<b>BARCODE SCANNERS</b> .....	26	Counters.....	42

# SUZOHAPP

SUZOHAPP is a technology company providing software and hardware for cash handling automation and self-service solutions to more than 25,000 customers throughout the world. SUZOHAPP's technology enables automation for customers operating in a variety of end markets, including retail, transportation, vending, banking, gaming and amusement. SUZOHAPP's solutions include cash deposit, recycling, processing and payment systems as well as a broad range of self-service component technologies. SUZOHAPP operates in 19 countries and its dealer network covers more than 100 countries.



1,100+ employees



50,000+ products



33 facilities



25,000 customers



115 engineers



Hundreds of patents



## VISION

To be the global market leader in technology-driven cash management, self-service, and gaming devices through our commitment to people, customers, and quality



## MISSION

To provide our customers with excellent service and high-quality components, solutions, and software that create significant value for their business



## CORE VALUES



AGILITY



CUSTOMER FOCUS



INNOVATION



INTEGRITY



RELIABILITY



TEAMWORK

## PRODUCT BRANDS

SUZOHAPP is a diverse company with multiple brands and product lines

**SCAN COIN**

Cash**Complete**™

**Comestero**

Bill**4**Bill™

**currenza** G<sup>2</sup>

**coinCO**

**VisionPro**™

**CompetitionPro**

**BilliardPro**

**InteractivePro**

We take pride in our products, we take care of our customers and we value our people

# Global Reach

SUZHOP is a global company with a worldwide presence and a diverse workforce. SUZHOP has grown rapidly to meet the needs of the markets, expanding the breadth of its product offering and service capability. Its best-in-class product and service offerings create significant value and operational efficiencies for customers all over the world.

- International coverage through national subsidiaries
- Worldwide presence with a global service network
- Distribution partners all around the globe
- Variety of customers across multiple business segments



## Around The World & Around The Corner

In addition to the offices and manufacturing sites located on the map, SUZHOP has strategic partnership agreements with Value Added Distributors, Gaming Channel Partners, and Contract Service providers in those regions where market or license conditions dictate.

## Your Strategic Partner

SUZHOP's logistical support and supply chain configuration builds on its total value proposition by providing customers with cost saving delivery "From Our Door to Your Production Floor". Through continuous communication and feedback, the SUZHOP supply chain team works closely with customers and factories to maintain a steady product supply while eliminating costly additional inventory. We are firmly committed to providing the best customer service to all customers.



# Manufacturing Capabilities

## Adding Value Through Manufacturing

SUZHAPP continually improves its engineering, manufacturing, service and distribution capabilities to meet the needs and exceed the expectations of its valued customers. With many years of industry experience and production excellence, SUZHAPP has developed innovative customer-centric engineering and manufacturing processes.

SUZHAPP designs and manufactures products that are used extensively in Gaming and Amusement devices as well as in demanding Industrial, Vending, and Transportation applications. In-house design, development and production resources located in multiple SUZHAPP facilities, ensure that projects are efficiently taken from concept to completion.

## DESIGN & ENGINEERING



Design & Prototyping

### Equipment

- CAD workstations
  - Pro/Engineer
  - SolidWorks
  - AutoCAD
- FDM prototyping machine (3D printing technology)

### Capabilities

- Quick turn-around
- In-house prototyping

### Resources

- 30 Engineers
  - Electrical
  - Mechanical
  - Software

## LCD, TOPPERS & KIOSKS



LCD Production

### Equipment

- Integrated toppers
- OEM open frame
- LCD integration
- Signage & custom assemblies
- Bid specification & RFQ

### Capabilities

- 20,000 pieces per year

### Resources

- 3 Engineers

## PLASTIC INJECTION, TOOL & DIE



Direct Injection

### Equipment

- 5 - CNC mills
- 5 - Lathes and grinders
- 1 - Wire EDM
- 28 Injection machines

### Capabilities

- Sizes from 25-1,600 tons
- 20 million pieces per year
- 24-hour operation
- Insert & over-moulding
- Design to first shoot within 10 days
- 15 tools per month

### Resources

- 65 dedicated staff
- +35 flex staff

## PCB PRODUCTION



PCB Production

### Equipment

- SMT high speed mounter
- SMT inspection
- Wave solder

### Capabilities

- Surface mount
- Through-hole
- 150,000 boards per month

### Resources

- 25 dedicated staff
- +15 flex staff

## ASSEMBLY



Assembly

### Equipment

- 12 - Conveyor lines
- 30 - Workstation cells

### Capabilities

- 50 assemblies per hour, per line/cell
- Service and Repair
- Assemblies with up to 1,000 components

### Resources

- 100 dedicated staff
- +100 flex staff

## QUALITY ASSURANCE



Quality

### Highlights

- ISO 9001
- Testing services and capabilities

### Resources

- 30 FTEs in area of quality control and assurance

## Manufacturing and Distribution Facilities



### Manufacturing Site and Logistics Hub Poland

- Poznan, Poland
- 20,000 sqm
- 190 employees
- 400 product lines produced daily
- Coin validators, coin and bill recyclers, change machines, cash points for self-service laundrettes, car wash starter systems, cash management solutions



### Manufacturing Site China

- Zhuhai, China
- 12,000 sqm
- 250 employees
- Turnkey design / manufacture
- Interactive touch displays
- Transparent LCD technologies
- Cash handling technologies
- Printers, card/barcode readers, NFC/RFID, cameras
- Kiosks, loyalty and betting terminals
- Digital signage
- LED lighting and back lighting technologies



### Manufacturing and Distribution Site North America

- Mount Prospect, IL and Las Vegas, NV production locations
- Over 6,000 sqm
- Assembly, Distribution, Service and Support
- Cash Management Solutions: Note recyclers, coin recyclers, deposit safes
- Components & OEM: Joysticks, buttons, coin doors, LCDs, reel mechs, toppers, game controls

# R&D Capabilities

## Investment in research and development is a top priority

Global product management teams meet continuously to develop new products and custom solutions for customers' ever-changing needs. Dedicated industrial, mechanical, and electrical engineering teams provide complete design, as well as component selection. SUZOHAPP utilizes contemporary modelling technology to produce accurate designs with competitive costs and short lead times.

## Technology Centres

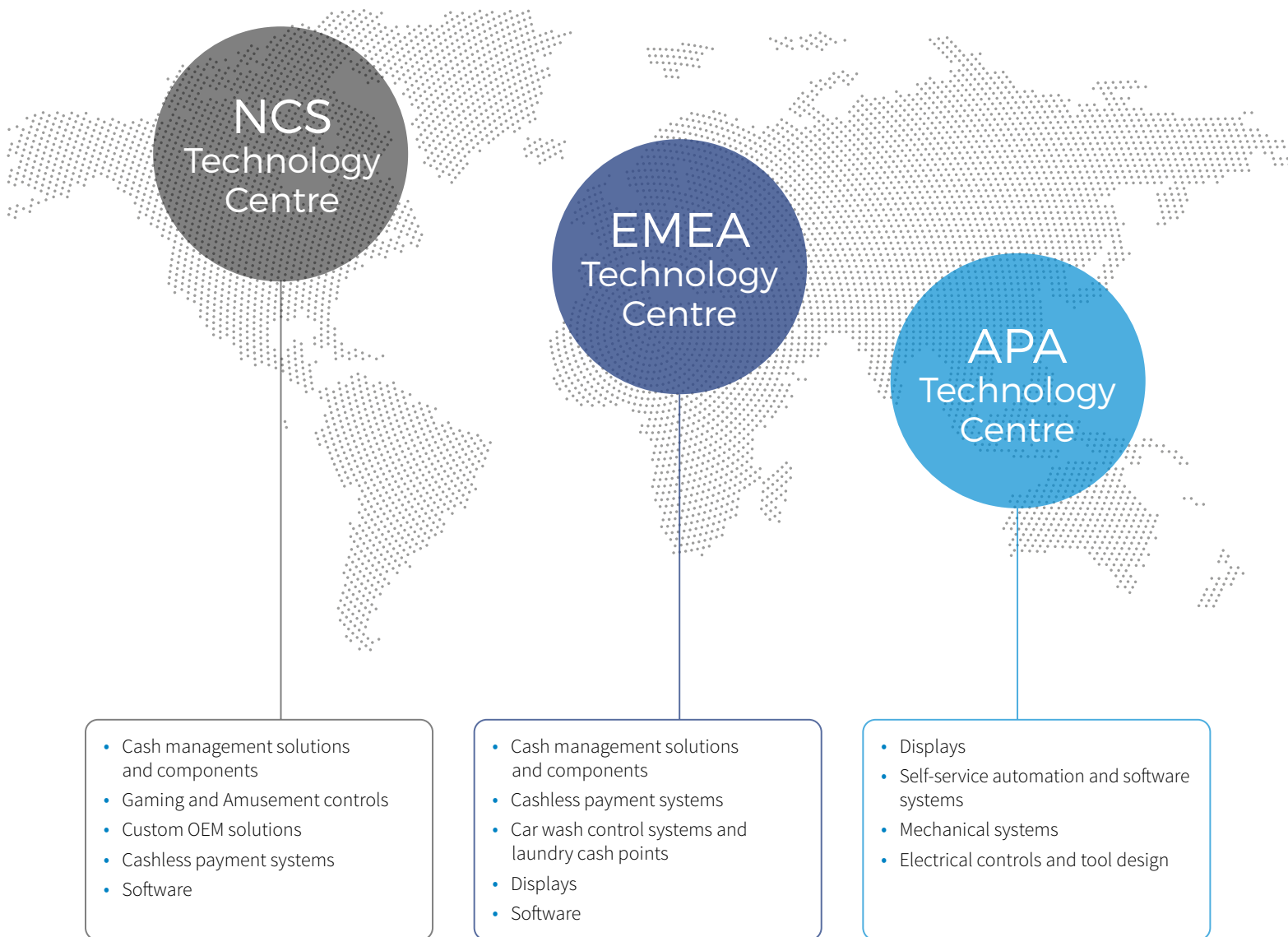

SUZOHAPP's Research & Development team is centralized into one global engineering centre of excellence, SUZOHAPP Technology Services (STS). This highly skilled department develops and supports the company's core technology, accelerates new product development and leads the introduction of innovative technologies.



## Design activities and expertise provided include:

- Turnkey design/manufacture of individual parts to complete machines - from concept development through final, highly engineered solutions
- 2D and 3D CAD Design – using SolidWorks for part/assembly modelling and drawings
- Metalwork/plastic design and electrical/wiring harnesses, virtual and physical prototyping, and product renderings
- Design of injection moulds and tooling
- Rapid prototyping through in-house 3D printing capabilities
- Proprietary electronics and PCB Design using the leading software package Altium
- Programming for microprocessors and Advanced Risk Machines (ARM, software development in most operating systems including Windows, Linux and Android OS
- Compliance testing and documentation, including UL

## Examples of some of the technologies SUZOHAPP works with:

- The latest LCD and touchscreen technologies, including projective capacitance
- LED lighting and back lighting technologies
- Embedded micro controllers and CPUs
- Electromechanical and mechanical systems

SUZOHAPP's dedicated team has been central to the success of many product deployments to the global amusement, gaming, industrial, transportation and vending markets.

## Projects have included:

- LCD retrofit integration
- Custom designed displays, including transparent LCD technology
- Interactive touch displays, large and small
- Cash handling technologies
- Printers, card/barcode readers, NFC/RFID, cameras
- Kiosks, loyalty and betting terminals
- Digital signage



## Workshop Service

Highly experienced lab technicians can repair parts to component level, utilizing the latest diagnostic equipment and techniques. SUZOHAPP can also redesign, re-engineer, restore or re-manufacture parts and components reducing your business maintenance costs.

### Repair Services

- Electronic gaming machines
- Jackpot systems and player tracking hardware
- POS systems, ATMs, self-service terminals
- Cash handling – bill acceptors, coin mechanisms, hoppers
- Data scanners, PDAs, PC mainboards, logic boards
- LCD displays, touchscreens
- LCD and CRT monitors, power supplies
- Electronic assembly and manufacturing services
- Electronic kiosks
- Wagering terminals
- Other electro-mechanical assembly work

### SUZOHAPP technicians are highly skilled

- IPC certified specialist technicians ensure the highest quality in surface mount, hole through and wave soldering
- Experienced in repairing multilayer boards
- Ability to perform circuit programming (FPGA, JTAG) and program microprocessors (TQFP, SSOP, EPROM)

### SUZOHAPP technical experts:

- Re-work and re-flow BGA ICs
- Give logic boards, main boards and A-D boards a new lease on life
- Refurbish circuit boards for most popular gaming machines and electronic equipment
- Repair bill validators, ticket printers, hoppers and coin mechanisms, giving considerable savings compared to the cost of replacement

Your Complete Source for Kiosk,

# Kiosk



Simplify Your Sourcing with Our Broad Product

[suzohapp.com/kiosk](http://suzohapp.com/kiosk)

## Vending



Range, Local Resources, and Global Capabilities

# Ticketing

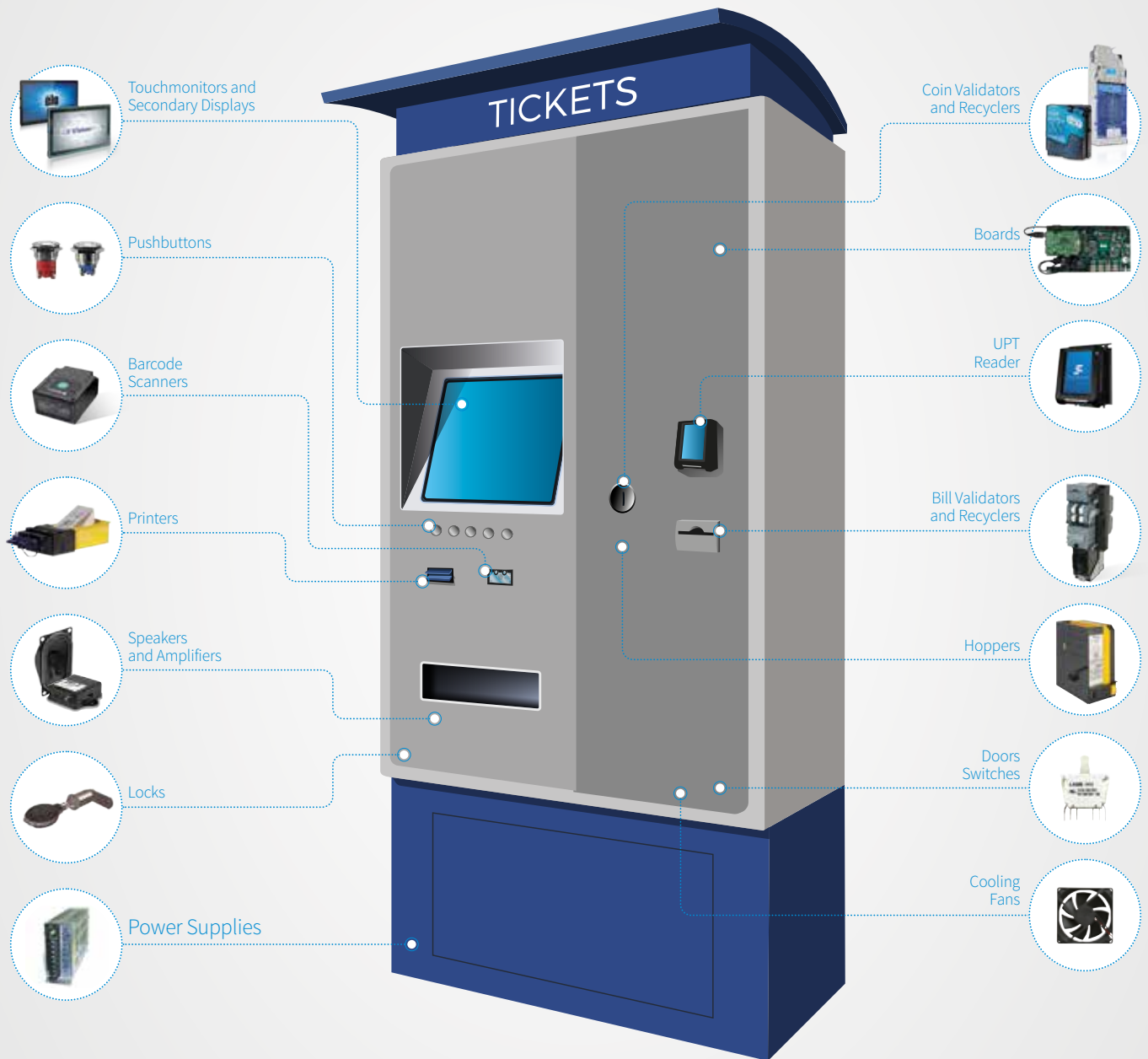

# Bill-to-Bill™ Range

## The Most Efficient Currency Management System Designed to Validate and Recycle Banknotes

The Bill-to-Bill™ is a fully integrated, high-security, frontloading system that utilizes advanced bill recycling technology for cash and cashless transactions. Bill-to-Bill™ banknote recyclers provide all-in-one automated cash management solutions that optimise the cash-in-transit and revenue collection operations. By adopting banknote recyclers, operators can achieve higher customer throughput, higher cash replenishment rates and lower cash-in transit costs.



# Bill-to-Bill 300™

## Intelligent Bill Recycling

The Bill-to-Bill 300™ is the multi-width front load bill recycler characterized by an advanced sensors technology that improves authentic bill recognition and protects against counterfeits. The validated bills are distributed between three recycling cassettes and one lockable-removable drop cassette. A maximum of 3 denominations may be directed to the recycling cassettes, and other denominations to the drop cassette.

- Best in class 3-denomination recycling
- True modular design and field upgradability
- Field proven reliability with 15,000+ unit installed base

- 98% + first time insertion acceptance rate. Acceptance speed: 2.3 seconds per banknote
- Industry's first self-centering mechanism
- Bill width validated: 67 to 71 mm wide (fixed width) and 62 to 82 mm wide (multi width), length of bill: maximum 172 mm, minimum 124 mm
- Bill acceptance: lengthwise in 4 directions
- Up to 3 recycling cassettes (each cassette holds up to 100 notes): "smart" cassettes save content information for easy swapping, individually configurable to any denomination
- Barcoded coupons: 2 ways face up (encoding standard: ANSI/AIM BC2-1995, Uniform Symbology, Interleaved 2 of 5)
- Multi-note dispenser for dispensing up to 20 notes in bulk
- Anti-stringing protection
- Up to 2 high-security locks protecting 1000-note metal cashbox contents (one additional lock to lock cashbox to device)

# Bill-to-Bill XE™

## Advanced Technology for Fare Collection

Bill-to-Bill XE™ is an innovative bill validator with patented technology allowing for high acceptance rates and a superior counterfeit detection. It validates, recycles and dispenses banknotes reducing the overall cash on hand and the operating costs. A system of custom high-security locks, RFID tracking, and external bezels protect cash when in TVM, during maintenance, and during transportation.

### Features

- ▶ **Validation technology**  
Optical, capacitive and inductive sensor technology
- ▶ **Sensors**  
Patented optical, inductive, dielectric and cross channel
- ▶ **Bezel**  
Choice of single metal bezel or dual bezel design
- ▶ **Sense-a-Click™ sensor pack**  
Four version as are available depending on currency set
- ▶ **Dispensing Cassette**  
Dispenses up to 20 bills in bulk
- ▶ **Multi-escrow application**  
All validated bills will be directed from the validating head into the recycling cassette
- ▶ **High impact resistant cash vault**  
Durable, metal chassis
- ▶ **MCBJ 1:20,000**, for any situation that requires a service call





Up to 3 Recycling Cassettes  
(each cassette holds up to 100 notes)

- ✓ "Smart" cassettes save content information for easy swapping
- ✓ Individually configurable to any denomination

## Bill-to-Bill TD™ Top Dispenser

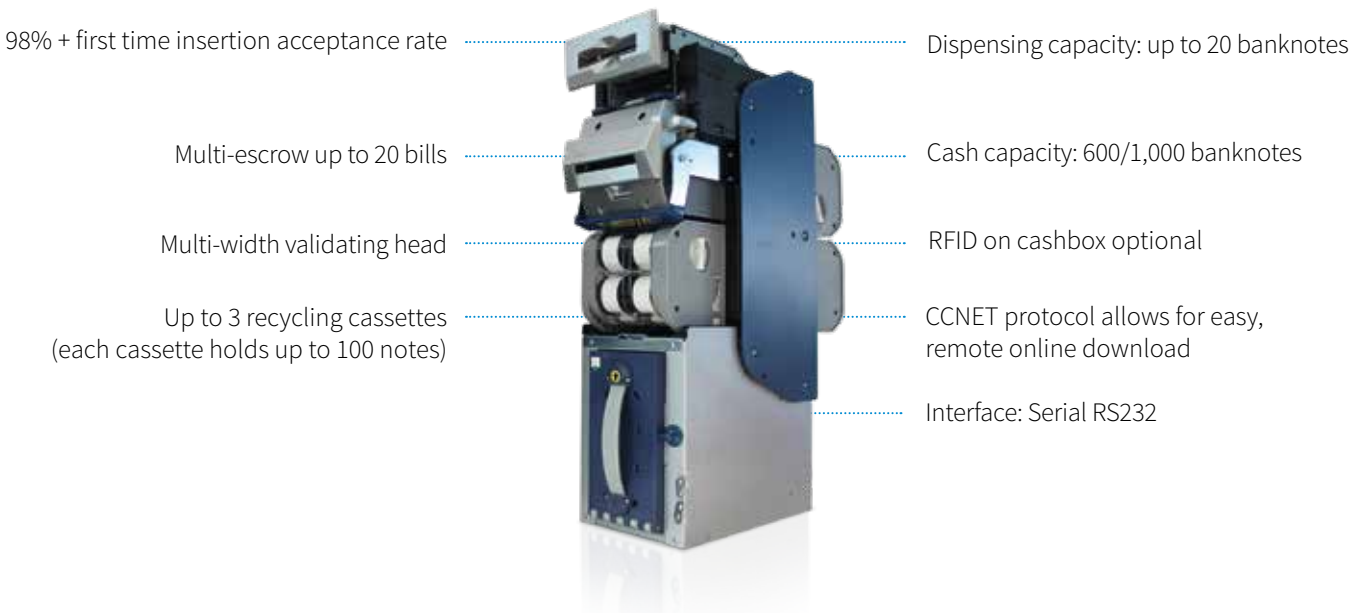
Ideal for fare collection, Bill-to-Bill TD™ Top Dispenser recycles up to three denominations and dispenses multiple banknotes in one operation, with a great choice of bezels and easy firmware updating using the memory card or through the host. The banknote dispenser has been moved up closer to the validating module to satisfy the law requirements and to give a user-friendly experience during the transaction, by requiring the customer to reach a shorter distance between the two openings.



## Bill-to-Bill ST™ Stackerless

Bill-to-Bill ST™ Stackerless is the smallest banknote recycler that maintains one of the highest recycling capacity. It is the first 3 denomination banknote recycler with free-fall capabilities. Bill-to-Bill ST™ Stackerless offers an easy upgrade path from a single note recycler to a full 3 note recycler with escrow functionality to provide flexibility.

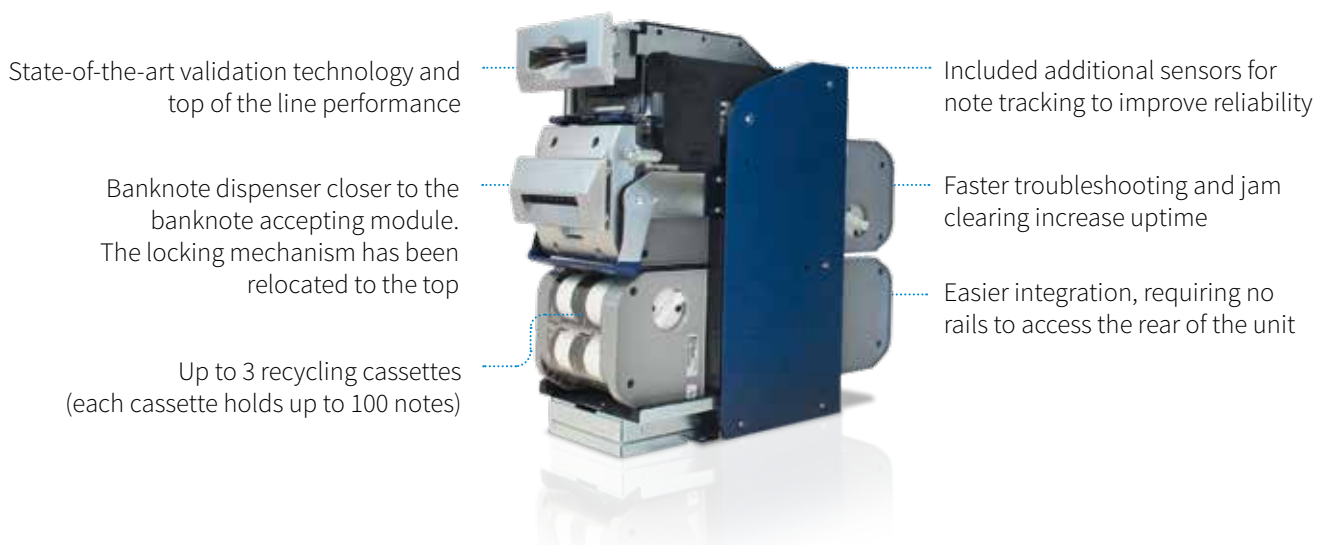

# MFL®

## Industry's Most Reliable, Secure, Modular Design

MFL® is the front load banknote validator designed for automated cash transaction applications. MFL® provides modularity and high security due to unique multi-sensor technology. MFL® utilizes a patented alignment mechanism enabling a high acceptance rate for banknotes and barcode vouchers. Due to its robust design and higher reliability, MFL® lowers total cost of ownership, enhances protection against counterfeits and improves machine uptime.

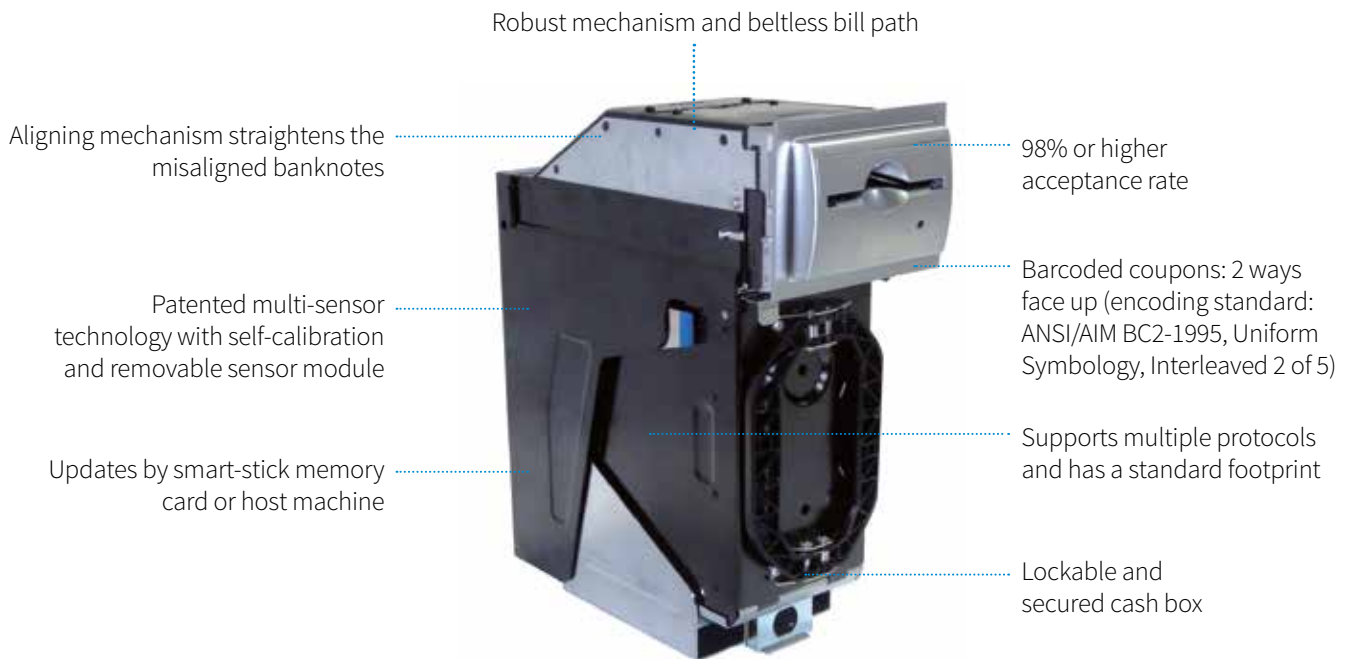



# Vantage

## Increase Your Profits with the Vantage Advantages

Vantage bill validator is an industry-leading solution with a host of advanced features for highest in-service time. Extremely robust and flexible, Vantage is designed to enhance operator business by maximizing profitability.

### Highlights:

- ▶ Advanced bill image processing and dynamic sensor calibration offers industry leading bill acceptance and fraud protection
- ▶ Proprietary Smart Bezel increases sales by actively communicating 5€, 10€, and 20€ bill acceptance in real time
- ▶ Quick-release bezel speeds installation and removal, improving access while reducing service costs
- ▶ Three levels of anti-stringing technology provide superior cheat resistance
- ▶ Capture new customers with eye-catching impulse lights
- ▶ Sculpted 360° illuminated bezel offers ease of bill insertion
- ▶ Automated self-diagnostics ensure optimal performance resulting in fewer service calls



### More Profitable

New features to increase your in-service time and sales.

- ▶ Centric driver roller provides highest acceptance rates for skewed bills
- ▶ Automated self-diagnostics and visual bezel notification guarantee your validator is always ready to accept cash
- ▶ Smart Bezel™ increases sales by communicating 5€, 10€ and 20€ bill. Multiple acceptance in real time

### More Robust

Innovative technologies enhance reliability and security.

- ▶ Fourteen sensor pairs scan more of the bill. Multiple analysis technologies increase acceptance while eliminating frauds
- ▶ Streamlined bill path and intelligent bill transport software reduces jam conditions providing highest in-service time
- ▶ Level Three Cashbox Lockout Technology provides industry leading security by completely blocking bill path access to the cashbox

### More Flexible

Easier to install, service and update.

- ▶ Quick-release bezel expedites installation and removal, even for tight installations
- ▶ Tool-free disassembly eases service. Illuminated bezel and status indicators simplify setup and troubleshooting
- ▶ FlexStack® cashbox holds over 500 bills. It maximizes bill capacity and reduces machine visits
- ▶ Broad range of support tools and accessories to meet your specific application

# Currenza C<sup>2</sup>

## Reduce your Machine Downtime and Increase Revenues

Currenza C<sup>2</sup> represents the latest innovation in coin acceptance and recycling technology. Thanks to the PRP (Payout Redundancy Protection) system, six tubes and three independent motors, it delivers superior results to vending operators in terms of high coin capacity, excellent payout reliability and maximum configuration flexibility. Currenza C<sup>2</sup> takes cash management to the next level by maximizing operators' profits and reducing machine downtime.

### Highlights

- ▶ Acceptance and payout of all circulation coins (also 0,01 €)
- ▶ 6 self-filling tubes reducing refilling needs and providing optimum set-up of payout configuration and float level and easy access in case of maintenance
- ▶ Modular cassette structure for great freedom in tube configuration
- ▶ Payout combination optimization to meet each machine's planogram and site users payment behavior
- ▶ High payout speed of up to 6 coins per second and acceptance speed of up to 3 coins/second
- ▶ MFT technology providing a more secure coin validation, sensor system to measure up to 40 different parameters
- ▶ Easy and fast programming with user-friendly intuitive menu
- ▶ Easy access to validation and sorting area for maintenance

### Optional Accessories

- ▶ External box to connect Currenza C<sup>2</sup> to small automatic and semi- automatic vending machines

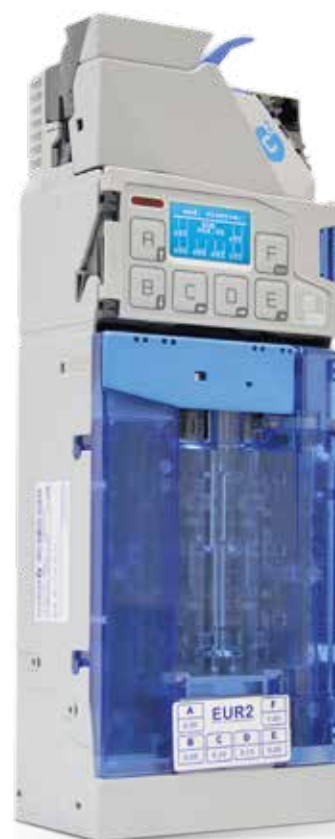

#### PRP System (Payout Redundancy Protection)

6 tubes cassette and 3 independent motors for high payout safety and the minimization of down time

### Versions

- ▶ **Blue (EXE, MDB)**  
with display and keys
- ▶ **White (MDB)**  
without display and keys



## RM5 HD

### Extreme Reliability, Remarkable Acceptance Speed and High Versatility

The RM5 HD coin validator has set new reference standards in coin validation. Through 5 different sensors and 10 recognition parameters, it ensures a high level of recognition and discrimination of valid and counterfeit coins with an unprecedented speed of up to 6 coins per second.



HD high-discrimination system based on 10 different parameters regarding frequency, dimensions and phase

5-sensor identification technology: 3 inductive sensors, 1 optical sensor and 1 magnetic sensor

USB version also available

Advanced electronic and mechanical anti-fraud system: electronic anti-fishing device, coin movement direction detection, 3 mechanical traps, and wire cutting blade

Tropicalised version also available for environments affected by adverse weather conditions

Over 2 million Comestero Coin Mechanisms Installed!

## RM5 Evolution

### The Record-Breaking Coin Validator

The RM5 Evolution coin validator is well known for its quality and reliability. Its electronics combines extraordinary selectivity with extreme programming versatility: the Cloning system allows the transfer of the configuration parameters.



3 pairs of inductive sensors for processing 6 different parameters regarding the material and the mass

3 pairs of optical sensors for determining the coin's diameter

Identification channels: up to 59, each of which can be redirected to the outlets. The first 6 support Self-Prog mode

A mechanical and electronic anti-fishing device

Serial interface for external connections (portable programmer or PC)

Credit recognition: parallel, binary, pulse

# Coin Sorters

## CINCO

Coin sorter with 5 sorting paths plus reject mechanism specifically designed to satisfy the requirements of any type of gaming machine. It can be installed both on machines operating in ccTalk and in parallel, allowing switching modes with ease.



## SPS41LCC4

Coin sorter with 4 in-line sorting paths and reject placed over the third sorting outlet.

## SPS31LCC3

Coin sorter with 3 in-line sorting paths and reject placed over the third sorting outlet.



## SPS31SCC3

Coin sorter with 3 in-line sorting paths and reject placed over the last sorting outlet.

## SPS300CC3/VER-B

Coin sorter with 3 in-line sorting paths and a bottom reject mechanism.



## SPS300CC3

Coin sorter with 3 in-line sorting ways and front reject.

# ICS (Intelligent Coin System)

## The Innovative Coin Handling Device

The ICS is a revolutionary coin handling device able to process up to 8 different size coins without the need of pre-sorting the coins by the user. Due to its compact design and spacious size (up to 1,300 various sized coins), it is ideal for many applications, and supports a minimum coin-in to coin-out height solution. Thanks to its patented design and SUZOHAPP's long-standing experience in coin handling, this device is the world's first currency solution able to be integrated into machines from diverse markets including parking ticket machines, self-checkout stations, money changers, kiosks and vending. ICS's intelligent interface gives you the possibility to directly manage the payout composition or make the calculation itself as to the amount of coins per type to be supplied based on the denomination it holds. It is also able to dispense 4 coins simultaneously.

NEW



\* value can change according to currency

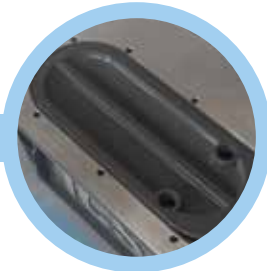

Compact design: one product that works as 8 hoppers + 1 sorter



High payout speed and safety: it guarantees the correct payout per coins' denominations

# Cube Hopper

## High Speed Single Denomination Hopper

The Cube Hopper has an expandable hopper capacity and is made from extremely strong, wear-resistant plastics. With one configuration it covers different coin sizes, and in case of conversion the disc can be replaced in seconds to convert the denomination of the hopper. The hopper is square and easy to mount by means of standard mounting bracket. By using an unique “Sun & Planet” gearbox system, this hopper offers the possibility to contain and count (with two extensions) over 1,200 coins of ø 24 mm. The hopper is protected by an auto-reverse anti-jam system and has an indirect optical readout with a continuous monitored optic sensor control. A low-level detection is integrated in the coin cup. A Dual Hopper version is also available which can payout two different types of coins.



# Flow Hopper

## Innovative Through-Hole Hopper

The innovative electronics and high-resistance plastic materials ensure durability over time. Available in two interfaces – standard parallel and ccTalk serial. Supplied with quick-release plate.



3 DIFFERENT COIN BOWL SIZES



Medium cup

Intermediate cup

Large cup

# Evolution Hopper

## High Dispensing Speed and Reliability Come Together

Based on a belt drive, Evolution Hopper is excellent in terms of both performance and ease of maintenance. The unique concept provides a single build type hopper that is suitable for 95% of the world's coins and tokens without needing adjustments. A large DC motor in combination with an electronic motor control board yields reduced friction and motor noise. The optic board is easily accessible by removing the electronic control board from outside the hopper.

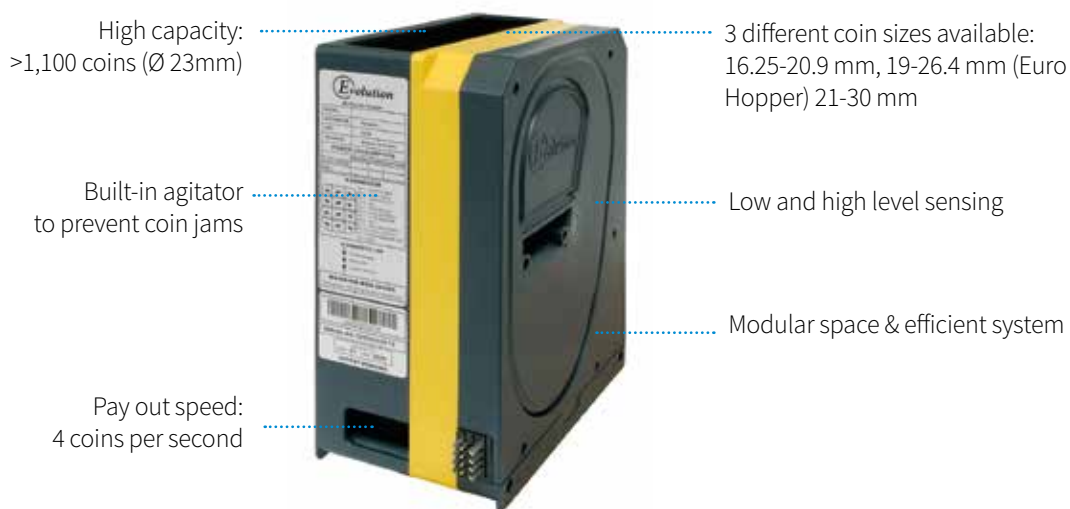

# Excel Hopper

## Extremely Durable and Service-Friendly

Its gearbox system design provides advantages such as maximum torque with minimum power consumption, unique bayonet motor connection for easy motor replacement, and an easily-accessible coin exit. Available with 3 different bowls: standard bowl, wide or narrow bowl and extended bowl.

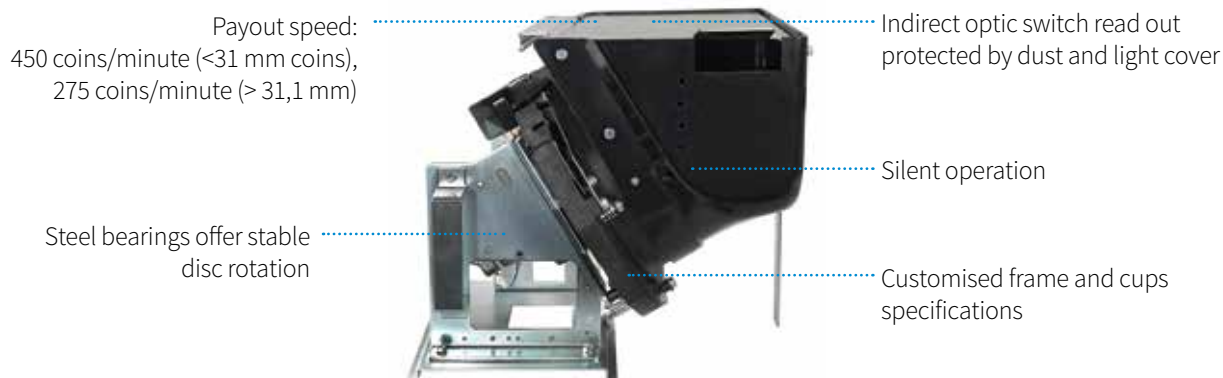

# Coin Carousel WGR

The WGR coin carousel not only stores coins but acts as an escrow to return rejected coins and serves as a payout mechanism. The escrow returns coins already entered, acting as Last-In/First-out (LiFo) mechanism. The WGR is powered by a bidirectional drive motor and the coins are taken by an electromechanical shutter. The current motor position and the shutter position are both monitored by a slotted optical switch. To recognized coins, the entrance is monitored by 3 light barriers. The major design innovation of the WGR is the carousel with 53 compartments in which 50 entered coins can be stored. The carousel's mechanical design allows all coin handling to take place within this unit. The modular design of the WGR allows several carousels to be placed on top of each other by using a simple rack construction in a complete coin storage and payout system.

## Features

- ▶ LiFo (Last-In/First-Out) function
- ▶ Coin overflow to the cash box
- ▶ 3 optical sensors for coin entry, motor and shutter positions
- ▶ 3 coin channels for acceptance, overflow and reject
- ▶ Easy way to insert several WGR carousels on top of each other to form a coin handling system. Each separate coin value is thus assigned to a separate magazine. A CPU controls the whole process and drives the magazines (available as option)
- ▶ If all compartments are full, then the coin that was first accepted reaches the overflow opening in the base of the WGR, and consequently falls through the opening when the next coin enters the magazine
- ▶ As each magazine is placed directly on top of each other, the coin will fall through the magazine under it and thus into the cashbox. A coin exit sensor is inserted underneath the magazines to ensure that the CPU is informed of any misrouted coin (available as option)



LiFo (Last-in/First-out) function



Possibility to use several WGR carousels



# UPT Card Readers

## All-In-One Solutions For Digital, EMV Contact and Contactless Payments

The UPT Card Readers are certified, 4G Ready, and feature beautiful large full-color touch screens, providing an attractive interface with ultimate payment flexibility for your customers. The UPT Card Readers can even accept and integrate with campus card systems in addition to digital, EMV contact and contactless payment cards. Built-in 4G telemeters report machine health data to management systems.

COMING SOON



UPT-B Card Reader  
With Bill Validator Bezel



UPT-F Card Reader

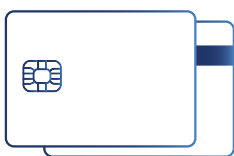

Certified



4G Ready



Large Full-Color  
Touch Screens

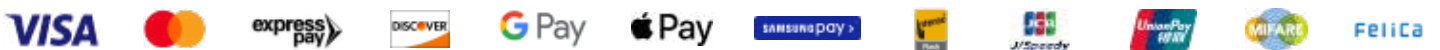

# Stationary Scanners

Newland scanners are supported by EasySet – a software tool for configuration, cloning setup for fast deployments, firmware upgrades, imaging functions, and includes a barcode generator.



NEW

## FM3080

Impressive short-range scanning capabilities combined with customization

Prepared for integration in your kiosk or counter, the FM3080 Hind combines performance and customization. The large scan window is optimized for short range reading of barcodes from a mobile phone or paper, even placed directly on the glass. With 4 color options available, the FM3080 Hind can be easily programmed to indicate a successful read or to match your brand.



## FM100

Reading performance reaches and exceeds global standards, advanced CCD scan engine  
Designed for OEM applications, this high-performance fixed scan engine can easily be integrated into various solutions such as kiosks, ticketing machines, (reverse) vending machines and many more. CCD technology means no laser, mirror or moving parts for increased durability.



## FM430 Barracuda

Read barcodes from short or long range with this compact scanner for when less space is available

The new FM430 Barracuda is Newland's most aggressive and efficient fixed mount scanner to date, making it a strong all-around solution. It's equipped with a megapixel camera that scans virtually any 1D and 2D barcode with impressive speed and ease. On top of that, its programming, IR sensor and light sensor help keep users moving, even in low light conditions. The combination of these features makes the device a leader in its class.



## FM3051 Grouper II

Plug-and-play simplicity enhancing your experience right from the start

With its snappy barcode reading of virtually any 1D or 2D barcode, the FM3051 Grouper II is the perfect response to the trend of barcodes moving from paper to the screen. Built to read from contemporary LCD widescreen devices, the fixed scanner is ideal for mobile phone applications like loyalty programs and ticket validation. Whether it's an employee scanning a product label or a customer scanning a voucher on their mobile phone, barcode scanning is always easy and quick. The form factor and small footprint of the FM3051 Grouper II makes it easy to integrate into a kiosk. Also available in flush mount: the FM3056 Grouper II.



## FM3056 Grouper II

Plug-and-play simplicity enhancing your experience right from the start

The FM3056 Grouper II is a flush mount scanner with a minimal footprint. With a height of only 53mm, the device is small enough to fit into most kiosks, while the flush mount ensures that the device suits any business environment. Built to read from contemporary LCD widescreen devices, the fixed scanner is ideal for mobile phone applications like loyalty programs and ticket validation. Whether it's an employee scanning a product label or a customer scanning a voucher on their mobile phone, barcode scanning is always quick and easy. The FM3056 Grouper II is the flush mount equivalent of the FM3051 Grouper II.



NEW

## FR27

Latest technology, compact design, CPU-based scanner

Armed with Newland's latest-generation UIMG® technology, the FR27 can decode poor quality soiled or wrinkled barcodes with ease, even on a screen covered with protective film. Its exceptional motion tolerance and large FOV enhance the user experience. Fits on a narrow desk or shelf when space is at a premium.





### FR21 Neon

Ideal desktop scanner for mobile payment, customer loyalty and ticket verification

The FR21 Neon was built to create an optimal customer experience at the POS. It scans quickly and easily, even for the most inexperienced user, making it an ideal solution for applications like mobile payment, customer loyalty, cashback, and ticket verification. "Scan here" circle customizable with any sticker.



## OEM Scan Engines



### EM2037-V4

Delivers speedy and accurate scanning performance

No matter what type of barcode is presented, the megapixel camera allows users to scan 1D and 2D barcodes, including very small ones, with impressive speed and ease. In addition to excellent scanning of high-density barcodes, the EM2037-V4 also provides the added value of decoding postal barcodes.



### EM3080-W

Small, lightweight and easy for integration

The EM3080-W is Newland's smallest OEM scan engine. Including easy integration with a minimal footprint, the EM3080-W is the perfect solution for all-around scanning capabilities.



### EM2080

Snappy on-screen barcode capture

The CPU-powered EM20-80 is incredibly reader-friendly on smartphone and tablet displays, and features excellent near-field reading, a wide viewing angle and snappy reading.



### EM3396

Integratable into various OEM devices including kiosks, ticket validators, and PDA's

The EM3396 OEM scan engine with a bright laser aimer, offers stunning performance on 1D and 2D barcodes. It can be integrated into various OEM devices including kiosks, ticket validators and PDA's. Due to its light weight of only 4g, solid-state build and low power consumption, the engine is ideal for portable scanning devices.



### EM50S-10

Superior scanning performance

The EMS0S-10 / EMS0S-20 is a CPU-based scan engine that delivers stunning performance. Armed with Newland's sixth-generation of UIMG technology, decoding damaged or poor-quality barcodes is no match for this scan engine.



### EM1300

Compact and highly integrated design

Designed for OEM applications, this high-performance CCD scan engine can easily be integrated into various solutions such as kiosks, ticketing machines, PDA's and many more.



# WorldKey Systems

## Innovation in Cashless Management

The WorldKey range is composed of a wide array of Mifare® cashless systems that can fulfil any payment, activation, identification and recharging requirements. Designed to manage multiple applications, WorldKey systems are flexible, durable and reliable cashless payment solutions.



### Benefits:

<b>Cash in advance</b> The customer is paying today for the consumptions of tomorrow	▶ Positive cash flow!
<b>Pricing flexibility</b> Set up prices at any value. No restrictions related to cash denominations or bank card transactions	▶ Improves margins!
<b>Fast payment at purchase</b> 3 times faster than cash	▶ Increases users spending!
<b>Users differentiation</b> Users ID inserted in the payment media can be linked to users data and customized product and rewards	▶ Creates customer loyalty!
<b>Product promotions</b> Set up differentiated pricing by product through discounts or subventions	▶ Boosts sales!
<b>No transactions fee</b> Credit uploaded through cash insertion at the machine or at independent loading stations	▶ No recurrent cost!

### WorldKey is the Most Complete Cashless Range in the Market:

#### 5 Models



#### 3 Reading Heads



#### 4 Customizable Payment Supports



#### A Private Cashless Payment System and Powerful Customer Management Tool

The WorldKey system is based on the MIFARE® (standard, Plus, DesFire, NFC) technology platform which ensures high safety standards. Security in transferring data is ensured by the combination of the proprietary encryption MIFARE® and RFtech TDES (Triple Data Encryption Standard). Operators can manage several sales or identification applications by storing them on a single RFID support (card/key/tag/sticker). WorldKey supports the most used protocols (Executive, MDB, BDV) and is ready to integrate the Ethernet, RS485, CAN BUS, ccTalk and USB interfaces.



# High Quality Open Frame LCDs For Kiosks, Vending, and Ticketing Machines

Touch and Non-Touch



Fast customization is available for both OEMs and upgrades: 6.2" to 90", specialized panels and integration, customized metal and oversized glass, touchscreens and inputs.

## Features:

- ✓ Standard sizes from 15" to 43", smaller and larger sizes available with fast customization
- ✓ Up to 4K resolution
- ✓ Standard and wide viewing angle units available
- ✓ Choice of:
  - 10+ touch Projected Capacitive (PCAP), true-flat, seamless edge-to-edge glass with thru-glass capability
  - 3M Surface Capacitive (SCAP) touch technology
  - Protective Glass
- ✓ Common footprint for touch and non-touch variations
- ✓ DVI, VGA, HDMI and DisplayPort input options
- ✓ Economically priced
- ✓ Models also available with LEDs surrounding the display with color

Below is just a small selection of VisionPro™ monitors available. See [suzohapp.com/monitors](http://suzohapp.com/monitors) for a comprehensive list.

Model	Size/Aspect ratio	Resolution	Viewing angle	Panel Brightness	Contrast	Touch/Glass
49-1902-DA	19" 5:4	1280x1024	178°x178°	250 cd/m <sup>2</sup>	1000:1	Optional I/R USB or serial
150TFTx2157	21.5" 16:9	FHD	170°x160°	250 cd/m <sup>2</sup>	1000:1	3M touch or tempered glass
150TFTG2153	21.5" 16:9	FHD	178°x178°	250 cd/m <sup>2</sup>	1000:1	Black edge-to-edge tempered glass
49-3306-02	21.5" 16:9	FHD	178°x178°	250 cd/m <sup>2</sup>	1000:1	3M USB or serial
150TFTx2206Mxx	22.0" 16:10	1680x1050	178°x178°	250 cd/m <sup>2</sup>	2000:1	3M touch or tempered glass
150TFTx2382	23.8" 16:9	FHD	178°x178°	250 cd/m <sup>2</sup>	1000:1	PCAP and matching glass version
150TFTx2306xxx	23.0" 16:9	FHD	178°x178°	250 cd/m <sup>2</sup>	1000:1	3M touch or tempered glass
150TFTS2414Mxx	24.0" 16:10	1920x1200	178°x178°	300 cd/m <sup>2</sup>	1000:1	3M USB or serial
150TFTx2411xxx	24.0" 16:10	1920x1200	178°x178°	300 cd/m <sup>2</sup>	1000:1	3M touch or tempered glass
150TFTx2705X	27.0" 16:9	FHD	178°x178°	300 cd/m <sup>2</sup>	3000:1	PCAP and matching glass version

## Elo Touch Solutions Open Frame Monitors



### Brilliant Display. Superior Quality. Competitive Price.

Engineered and designed specifically to perform in some of the most demanding, high-touch environments, the 90-Series open-frame displays feature touch technology that is built-in rather than glued-on. Elo is the world leader in commercial touch with over 20 million installations, half a million units per year, nearly 2,000 units per day.

Select from a wide range of sizes from 10" to 27" to fit in your environment. Other Elo products extend the range to 70".

Only Elo produces the touchscreens, controllers, drivers, and monitors for a complete solution proven in over 20 million installations worldwide.

### Take advantage of these great features:

- ✓ Next generation Projected Capacitive (PCAP) 2GS technology (2 glass solution)
- ✓ Highest optical quality and longevity as no plastic films, no metal mesh
- ✓ 10-touch true-flat solution
- ✓ Thru-glass mode which operates through up to 6 mm customer-supplied glass
- ✓ Common mechanical and electrical components across the line for easy design-in, compliance testing, service, and transition between sizes
- ✓ HDMI, DisplayPort, VGA inputs, with common port design across all units
- ✓ Built-in watertight edge seal
- ✓ Magnetic tethered OSD control box
- ✓ Unique field-replaceable touchscreen glass design
- ✓ Global agency approvals: United States UL, FCC; Europe CE TÜV; Australia RCM; Canada cUL, IC; China CCC; Japan VCCI; Korea KCC; Mexico CoC; Taiwan BSMI; International CB; RoHS
- ✓ Passes UL and IK07 Ball Drop tests
- ✓ 50,000 hour demonstrated MTBF
- ✓ 3-year standard global warranty



New sleek finished enclosure

Model	Diagonal size	Aspect ratio	Contrast ratio	Brightness (panel)	Viewing angle	Native resolution
1093L	10.1"	16:10	800:1	350 nits	85°/85° or 170°/170°	1280 x 800 at 60Hz
1291L	12.1"	4:3	1500:1	450 nits	89°/89° or 178°/178°	800 X 600 at 60Hz
1590L	15"	4:3	800:1	300 nits	80°/70°- 80° or 160°/150°	1024 X 768 at 60Hz
1593L	15.6"	16:9	500:1	300 nits	80°/80° or 160°/160°	1366 x 768 at 60Hz
1790L	17"	5:4	1000:1	250 nits	85 °/80° or 170°/160°	1280 x 1024 at 60Hz
1990L	19"	5:4	1000:1	250 nits	85°/80° or 170°/160°	1280 x 1024 at 60Hz
1991L	19"	5:4	1000:1	250 nits	89°/89° or 178°/178°	1280 x 1024 at 60Hz
2094L	19.5"	16:9	3000:1	250 nits	89°/89° or 178°/178°	1920 x 1080 at 50, 60Hz
2293L	21.5"	16:9	1000:1	250 nits	85°/80° or 170°/160°	1920 x 1080 at 50, 60Hz
2294L	21.5"	16:9	1000:1	250 nits	89°/89° or 178°/178	1920 x 1080 at 50, 60Hz
2494L	23.8"	16:9	3000:1	250 nits	89°/89° or 178°/178	1920 x 1080 at 50, 60Hz
2794L	27"	16:9	3000:1	300 nits	89°/89° or 178°/178	1920 x 1080 at 50, 60Hz

10" to 27" desktop touchmonitors, All-in-Ones and interactive digital signage from 10" to 70"

SUZHAPP also distributes the complete line of Elo Touch Solution products — seen in interactive kiosks, point-of-sale terminals, interactive retail displays and transportation applications around the world.





Orizon™ NextGen™  
Smarter. Faster. Better.

The ultimate kiosk printer, combining technology (PC-based infrastructure), flexibility (adjustable spindle arm) and outstanding reliability (200km print head life).



PayCheck® Terminal™  
Low-cost hardware for interactive kiosks.

PayCheck Terminal XL is the world's first kiosk terminal powered by a TITO printer. Taking advantage of the power and uniqueness of the PayCheck NextGen printer, we created a Linux-based terminal for your gaming, lottery and retail applications.



PayCheck® NextGen™  
The 'ONE' printer you need!

Greater value, more reliable and more capable than any of its competitors on the market today, PayCheck NextGen is the 'One' printer venues need to ensure reliability, functionality and connectivity.



PayCheck® 4™  
Fastest. Smartest. Toughest.

Finally, there's a printer that's as fast as the gaming action on your casino floor. The PayCheck 4 Thermal Printer from Nanoptix® can print a ticket in just 0.6 seconds!







## PayCheck® Desktop 2™

The newest member of the PayCheck® series family

Powered with PayCheck NextGen technology, this desktop model can enhance your cage environment by providing your customers quick TITO tickets, promotional coupons and/or streamlined tax forms, to name a few, while keeping your host engaged one-on-one with your patrons.



## HSVL Advanced™

Better. Smarter. Faster.

The HSVL Advanced printer, provides manufacturers ultimate flexibility and outstanding reliability. By using innovatively designed movable spindle arms the HSVL Advanced can adapt to any kiosk design.



## EZ-Tear™

Compact. Flexible. Modular.

The EZ-Tear printer provides manufacturers flexibility while remaining compact and reliable. Built with modularity in mind, the EZ-Tear printer will fit many types of kiosks and with its clamshell design, provide easy access for paper loading.



## “Spill-Proof” Thermal Printer

Fast. Quiet. Efficient.

Affordable and easy to use. Best of all, its patent-pending spill-proof design means never having to worry about OOOPS again. IEC60529, IPX3 spillage approved.

# Kiosk / Self-Service Printers

Top technology for almost 30 years

NEW



## MODUS 3 Small footprint kiosk printer

Ultra compact thermal printer to meet the needs of slim-line kiosks without sacrificing features and functionality. MODUS 3 combines all the features of a self-service printer in a compact package (116Lx50Dx62H).



## TG02H Extremely compact and versatile ticket printer

Designed for easy installation and panel mounting, the TG02H is an extremely compact and versatile ticket printer and includes a patented anti-jamming system.



## TG1260HIII 60mm ticket / receipt printer

60mm receipt and ticket printer with a metal frame and paper mouth with blocking system to prevent insertion of items. Available in cutter and tear-off versions, 24V version (TG2460), and with illuminated plastic bezel.



## TG2480HIII 80mm ticket / receipt printer

80mm receipt and ticket printer with a metal frame, static presenter, and an exclusive patented anti-jamming system.



## VKP80III 80mm ticket / receipt printer

The worldwide best seller in the kiosk industry! The most compact 80mm ticket and receipt printer with fast printing and low TCO (Total Cost of Ownership). Available with shutter for outdoor use to prevent introduction of objects.

# Dynamic Panel Systems

SUZOHAPP's Dynamic Panel Systems (DPS) feature the latest innovation in pushbuttons - all the adaptability of touch screens with the tactile satisfaction of mechanical pushbuttons. We remove the limits of standard LCD pushbuttons in both shape and content, utilizing a single LCD with a unique fibre optic conduit to elevate the image to the surface of the injection moulded plastic lens cap. Easily program the entire deck at once with dynamic and configurable content allowing for unprecedented interaction with customers.

**Future-proof your user experience with SUZOHAPP Dynamic Panel Systems!**



## Benefits

- ✓ Dynamic content within a tactile format
- ✓ Ability to combine touch surface and multiple tactile video buttons all while utilizing the same LCD/TFT panel with single video input
- ✓ Decrease in maintenance and reliability concerns compared to single screen TFT/OLED buttons
- ✓ Display graphics, text, animations, video, and even highlight error states with moving colour
- ✓ Innovative use of precision image transfer fibre optics

### ▶ Innovation

SUZOHAPP's DPS feature Picture Key Technology at its core. This allows the dynamic picture to be elevated to the top face of your buttons. The revolutionary space-age fibre optic conduit provides the user with excellent visual clarity and enhanced interaction. Content is delivered using a single LCD, so you can reduce your development time and programming resources.



### ▶ Serviceability



The DPS' modular design enhances serviceability. Individual components can be replaced, allowing for efficient repairs and reduced downtime.

### ▶ Fluid Ingress Protection

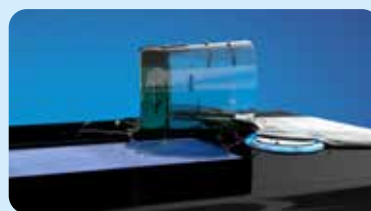

The robust design has been rigorously tested to prevent fluid ingress, preserving your game and maintaining uptime.

### ▶ Customization

Uniquely designed for a large variety of tactile and touch combinations. We will work with you to create the deck perfect for your next project.

Prefer a single bash button with a touchscreen? All tactile with no touch? **Your design possibilities are nearly limitless.**

# Chrome-Luminescent Pushbuttons

Polished chrome-plated button bezel with translucent color washer molded in bezel to provide edge luminescent effect. Available in several color combinations of button & luminescent effect. Additional customization also available.

- ▶ Locking nut has special design to allow it to fit over “Snap-Tab” feature with microswitch installed
- ▶ Ease & flexibility of mounting to metal control panels using either the “Snap-Tab” or traditional locking nut
- ▶ Switch pre-assembled on button for reduced assembly time into control panel
- ▶ Subminiature microswitch provides additional clearance room under control panel
- ▶ Polycarbonate lens for optical clarity and durability
- ▶ Switch snaps on bezel of button eliminating the need to have separate lamp holder
- ▶ Grounded for ESD protection



# STC Pushbuttons

STC Pushbuttons with Subminiature Microswitch. Available in 6 different colors: red, orange, yellow, green, blue or white.

- ▶ Designed to resist spills and sticking, for high reliability and long life, tested for 10 million+ cycles
- ▶ Standard supplied with spacer bezel for mounting on top or in the panel (low-profile)
- ▶ Full 0.5 mm thickness on lamp terminals holds lamp or led connectors securely
- ▶ For use with 5 mm wedge base lamps or leds (not included)
- ▶ Standard fitted with Cherry DB5 style microswitch with 2.8 mm terminals or easy connection



# LCD Pushbuttons

New and innovative addition to the SUZOHAPP product range. These interactive buttons give the designer additional tools for attracting new users.

- ▶ LCD is integrated into the button and moves with lens cap
- ▶ Light ring comes in a range of colors
- ▶ Option to customize LCD decal surround (black standard)
- ▶ 24 frames per second animation
- ▶ Full color 128 x 128 pixels
- ▶ USB interface, controller board controls up to 16 buttons



## Xlocks & STC Locks

### Security Camlocks Key Alike



- ▶ 10 pin operation
- ▶ Die cast housing with chrome finish
- ▶ Camlocks available in 3 lengths: 16 mm (5/8"), 22.3 mm (7/8") and 28.6 mm (1-1/8")
- ▶ Large key provides good grip during operation
- ▶ Key made of nickel silver material for trouble-free performance
- ▶ Standard supplied with 32 mm cam with dual hole so the lock can be mounted in any position

### Security Switchlocks



- ▶ 10 pin operation
- ▶ Die cast housing with chrome finish
- ▶ Length 36.4 mm (1-7/16")
- ▶ Large key provides good grip during operation
- ▶ Key made of nickel silver material for trouble-free performance
- ▶ Switchlocks have 6.3 x 0.8 mm terminals fitted for easy connection
- ▶ Switchlocks are available with or without automatic key return

### STC Round Key Camlocks



High reliable range of camlocks of different sizes to satisfy customer needs. The locks are available both as key different and key alike.

- ▶ 7-pin tumbler lock
- ▶ Housing with chrome finish
- ▶ Round chrome plated key
- ▶ Available as key different and key alike
- ▶ Available in: 16 mm (5/8"), 22.3 mm (7/8") and 28.6 mm (1-1/8")
- ▶ Cam included



All new key alike series are supplied in lots of 25, 50 or 100 pcs with a total of 5 keys per key code  
 Re-orders on the same key code are possible with a minimum of 25 locks per key code

# The Ultimate Electronic Reprogrammable Lock

Secure, Remote Access Control with Operational Visibility  
 Identifies each user, checks permissions, records each operation



Patented high-tech stainless-steel locking system with self-powered key sets

## Features

- Never again change locks when a key is lost, or employee dismissed
- Carry far fewer keys for your fleet or location
- Drop-in replacement for existing locks – self-powered, no wiring
- Remote authorization and traceability with Bluetooth option
- Automatically logs access times and user – no more manual logging
- Authorization reissued daily, or on demand
- Grant temporary access to technicians or others

## Design

- ✓ Standard cam or cylindrical formats, custom sizes available
- ✓ 90°, 132°, 180° rotation limiters, right and left
- ✓ IP65 for outdoor usage
- ✓ AES 128-bit encrypted communication
- ✓ Over 10 billion combinations



**Bluetooth Connectivity**  
 Fully control your locks from any remote location even from a smartphone or a tablet

Program a Unique-Code for each lock with multiple User Key access, or Multi-Code to pair each lock with multiple key codes for a hierarchical or simple master key system.

## E-PRL™

## Keys



Master Key

Programs lock pairing with User and Download Keys



User Key

Unique-Code or Multi-Code



Download/Audit Key

Retrieve access history stored in locks



Bluetooth Key

Communicates with smartphone or tablet to headquarters

## Accessories



Cylinder Adapter



Handles and Covers

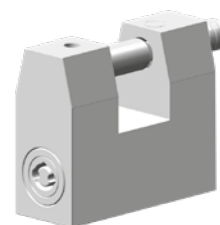

Padlock

## Software

- ✓ Retrieve lock history with the Download Key, insert in supplied USB Pod, and display/export the event history
- ✓ Create and check permissions, black and white lists, reprogram keys, set access time limits, monitor and control each operation
- ✓ Communicates from headquarters to iPhone or Android smartphone/tablet apps, and then to users' Bluetooth Keys
- ✓ Runs on a secure Cloud-based platform or your own server

Contact SUZOHAPP for a **trial kit** compatible with your existing locks!



## Speakers and Amplifiers

A wide range of speakers and amplifiers with terminals perfect for use anywhere a small footprint speaker is needed. Available in various sizes and voltages.



## Power Supplies & Line Filters

200W, 400W and 500W

High reliability power supplies with high efficiency and low working temperature. Available in different compact size and characterised by light weight.





# LED Light Strips

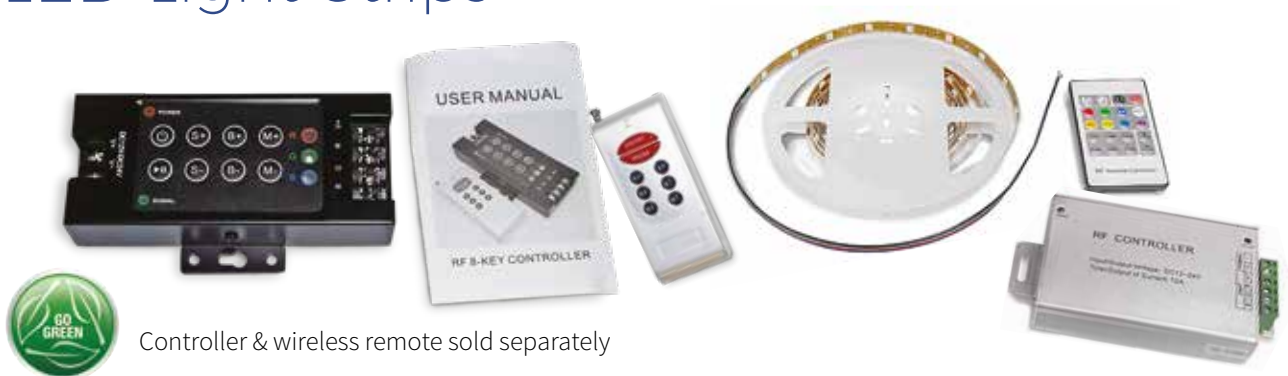

Controller & wireless remote sold separately

- ▶ Easily installs in or around your machines tention and increase earnings
- ▶ Very thin continuous length flexible LED light strips
- ▶ 5m rolls can be separated every 3 LEDs and reconnected again
- ▶ Super bright high-quality SMD LEDs per reel with 120° wide angle illumination
- ▶ 3M adhesive tape on back for easy installation
- ▶ Operates on +12VDC
- ▶ LEDs controlled by controller and wireless remote (sold separately)
- ▶ Each controller can run 65.62 feet (20 meters) of LED strips
- ▶ Long life: 50,000 hours
- ▶ Less power consumption than traditional lights
- ▶ No RF interference
- ▶ Sold in reels of 5m
- ▶ +12VDC; 20W

# Lamps

## Light PRO LED Tubes

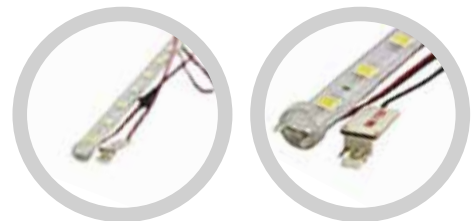

# Proximity / Motion Sensor

- ▶ Detects changes in position within a zone up to 5 meters
- ▶ Easy to use – sensor simply changes its output from 0 to 1
- ▶ SUZOHAPP part number 205140000184A

### Technical Specifications

Detection distance	5m
Field of view	22°x38°
Detection zone	24 beams
Detection condition	The temperature difference between the target and the surroundings must be higher than 4°C
	Movement speed: Digital output 0.8 to 1.2m/s Analog output 0.5 to 1.5m/s
	Target concept: Human body with an approx. size of 700x250mm
	Target moving direction: Crossing the detection beam



NEW

## Door Switches

### Single and Double Pole

- ▶ Choice of push and push-pull interlock switches
- ▶ Snap-in panel mounting
- ▶ Long-life coil spring, snap-action mechanism
- ▶ Temperature rating -40° to +85°
- ▶ Flammability rating UL94V-0
- ▶ Various approvals available
- ▶ Detailed datasheets available



## Cooling Fans



### DC Cooling Fans

- ▶ Compact cooling fans
- ▶ Wire connection
- ▶ 12 or 24 Vdc
- ▶ Speed up to 5800 RPM

### AC Cooling Fans

- ▶ Protects electronics from overheating
- ▶ Easy mounting with 4 bolts
- ▶ Terminal or wire connector
- ▶ Speed up to 3000 RPM



### Finger Guards for Cooling Fans

- ▶ Protects electronics from over heating
- ▶ Easy mounting with 4 bolts

## Counters

### SEC Starpoint Electronic Counter

Enhanced security is a major feature of the SEC, an unique fingerprint code allows the machine to detect any meter changes and to prevent operation if the meter is not present. By utilizing the latest electronic technology, the SEC avoids the reliability problems and service call-outs which can be experienced with mechanical counting devices.



- ▶ Replaces up to 31 mechanical meters with individual counters stored in EEPROM
- ▶ 7-digit LCD for displaying contents of counters
- ▶ Text messages and counter selection controlled by host machine

- ▶ Clocks serial interface designed to work on existing meter ports
- ▶ Improved security through:
  - Secure software protocol
  - Tamperproof counters with unique fingerprint code



SUZOHAPP

# Notes

Lined writing area for notes.

# Notes

A series of horizontal dotted lines for writing notes.

# CONTACT US

## EUROPE, MIDDLE EAST, AFRICA

### BELGIUM

SCAN COIN Belgium sa  
De Vunt 13 b 18  
B-3220 Holsbeek  
☎ +32 16 296 073  
@ info.hb.be@suzohapp.com

### DENMARK

SCAN COIN A/S  
Smedeland 6  
DK-2600 Glostrup  
☎ +45 43 63 06 44  
☎ +45 43 43 27 28  
@ info.gl.dk@suzohapp.com

### FRANCE

SUZOHAPP France SAS  
8 Avenue de l'Île Saint-Martin  
92000 Nanterre  
☎ +33 1 56 05 28 00  
@ sales.fr@suzohapp.com

### GERMANY

SUZOHAPP Germany GmbH  
Hamburger Str. 11  
22083 Hamburg  
☎ +49 40 54 76 130  
☎ +49 40 54 76 1330  
@ sales.de@suzohapp.com

### IRELAND

SCAN COIN Ireland Ltd.  
Bracetown Business Park  
Clonee, Dublin 15 D15 DH2N  
☎ +353 1 8014077  
☎ +353 1 8014129  
@ sales@scancoin.ie

### ITALY

Comestero Group S.r.l.  
Centro Direzionale Cassina Plaza  
Via Roma 108, Edificio F scala 1  
20060 Cassina de' Pecchi (MI)  
☎ +39 02 87 17 66 78  
☎ +39 02 95 38 01 78  
@ sales.it@suzohapp.com

### NORWAY

SCAN COIN AS  
Rosenholmsveien 20  
NO-1252 Oslo  
☎ +47 66 81 34 00  
☎ +47 23 382 939  
@ info.os.no@suzohapp.com

### POLAND

SUZOHAPP Polska Sp. z o.o.  
Składowa 1B, Koninko  
62-023 Gądki k. Poznań  
☎ +48 61 271 6060  
☎ +48 61 271 6061  
@ info.pl@suzohapp.com

### SPAIN

SUZOHAPP Spain S.A.  
Avenida Pirineos, nr. 7 Interior, nave B2  
28703 San Sebastián de los Reyes  
Madrid  
☎ +34 916 611 818  
☎ +34 902 446 777  
@ sales.es@suzohapp.com

Avenida de Cornellá, n. 142  
Planta 1ª Edificio Lekla  
08950 Esplugues de Llobregat - Barcelona  
☎ +34 934 802 878  
☎ +34 902 446 777  
@ sales.es@suzohapp.com

### SWEDEN

SCAN COIN AB  
Nordenskiöldsgatan 24  
211 19 Malmö  
☎ +46 40 6000 600  
@ info.se@suzohapp.com

SCAN COIN Intramat AB  
Marinvägen 5  
SE-471 41 Rönnäng  
☎ +46 40 600 06 00  
@ order.intramat@scancoin.com  
@ support.intramat@scancoin.com

### SWITZERLAND

SUZOHAPP Switzerland SA  
Route de Pra de Plan 17  
CH-1618 Châtel-St-Denis  
☎ +41 21 905 36 95  
☎ +41 21 905 44 12  
@ info.cd.ch@suzohapp.com

### THE NETHERLANDS

SUZOHAPP Netherlands B.V.  
Rijnzathe 12  
3454 PV De Meern  
☎ +31 (0)186 643333  
@ sales.nl@suzohapp.com

### UNITED KINGDOM

SUZOHAPP (UK) Ltd  
Units 1 & 2, King Georges Trading Estate  
Davis Road, Chessington,  
Surrey KT9 1TT  
☎ +44 208 391 7700  
☎ +44 208 391 7760  
@ sales.uk@suzohapp.com

Dutch House, 110 Broadway  
Salford Quays,  
Salford M50 2UW  
☎ +44 161 873 0505  
☎ +44 161 873 0501  
@ sales@scancoin.co.uk

SCAN COIN Technology Ltd  
22, Stafford Park, 12  
TF33BJ Telford  
☎ +44 1952 200 636  
☎ +44 1952 290 018

## NORTH, CENTRAL, & SOUTH AMERICA

### CANADA

SUZOHAPP Canada  
587 Hanlan Road  
Woodbridge, ON L4L 4R8  
☎ Local Phone: +1 905-851-9775  
☎ Tool free: +1 800-239-7017  
☎ Tech. Support: +1 847-593-6161 Ext 7733  
@ bill-to-bill@suzohapp.com

### USA

SUZOHAPP Americas  
1743 Linneman Rd  
Mount Prospect, IL 60056  
☎ Toll Free: +1 888-289-4277  
☎ Local Phone: +1 847-593-6130  
☎ Toll Fax: +1 800-593-4277  
☎ Local Fax: +1 847-593-6137  
@ info@suzohapp.com

SUZOHAPP Americas  
1385 Pama Lane Unit 100  
Las Vegas, NV 89119  
☎ Toll Free: +1 888-289-4277  
☎ Gaming Tech Support: +1 702-588-5365  
☎ Non-Gaming Tech Support:  
+1 847-593-6161 Ext 7124  
☎ Toll Free Fax: +1 877-870-2259  
☎ Local Fax: +1 702-597-4837  
@ info@suzohapp.com

SUZOHAPP Americas  
7745 Carondolet Ave., Suite 300  
Clayton, MO 63105  
☎ +1 847-593-6161  
☎ +1 800-593-4277  
@ info@suzohapp.com

## ASIA, PACIFIC, AUSTRALIA

### AUSTRALIA

SUZOHAPP Australia Pty Ltd  
44-48 Rocco Drive, Scoresby,  
Victoria 3179  
☎ +61 3 9757 5000  
☎ Free Call: +61 1300 00 7896  
☎ +61 3 9763 7265  
@ info@suzohapp.com.au

### CHINA

SUZOHAPP Asia Limited, Macau  
Avenida Venceslau de Morais no. 157  
Kek Seng Industrial Building  
Phase 2, 2nd Floor-L  
Macau  
☎ +853 2895 6289  
☎ +853 2843 7019  
@ info@suzohappasia.com.mo

SUZOHAPP China Limited  
Shenzhen branch  
Room 5405, Chun Hing Square  
Diwang Commercial Center, Luohu District  
Shenzhen  
☎ +86 0755 2512 3746  
@ info.ko.hk@suzohapp.com

SUZOHAPP China Factory  
Zhuhai Factory  
3 Airport North Rd, Sanzao  
Jinwan District, Zhuhai, 519040  
☎ +86 7567511630  
☎ +86 756 7511283  
@ info.ko.hk@suzohapp.com

SUZOHAPP Hong Kong Limited  
Unit B, 3/F, Dragon Industrial Building,  
93 King Lam Street, Lai Chi Kok, Kowloon  
Hong Kong  
☎ +852 25906438  
☎ +852 2590 6423  
@ info.ko.hk@suzohapp.com

Coin Acceptors (Suzhou) Co., Ltd.  
401, Block D, No. 5 Xinghan Street, Suzhou  
☎ +86 512 67613283  
☎ +86 512 67613279

### INDIA

SUZOHAPP India  
803, Lodha Supremus, Road no. 22  
Wagle Estate,  
Thane (West), 400604  
Mumbai - Maharashtra  
☎ +91 22-25833388/99

© 2019 SUZOHAPP

All rights reserved. Specifications subject to change. 01-21-20

Trademarks owned by their respective holders.

No part of this catalogue may be reproduced in any form by print, photoprint or any other means, without written permission from the publisher.

Technical data, text and pictures are subject to error and modifications.

The catalogue can be subject to further developments.

